

Change of the ultrasonic characteristics with stress in some steels and aluminium alloys

SENNOSUKE TAKAHASHI

National Research Institute for Metals, Naka-Meguro, Meguro-ku, Tokyo, Japan

EIJI YAMAMOTO, NORIAKI UETAKE, RYOHEI MOTEGI

Tokyo Keiki Co., Ltd., Minami-Kamata, Ota-ku, Tokyo, Japan

Under application of tensile stress to specimens of several steels and aluminium alloys up to a stress close to their yielding stress, a continuous ultrasonic wave of approximately 5 MHz was propagated through the specimens in directions parallel and perpendicular to the tensile axis. The change of ultrasonic resonance frequency with applied stress was measured. The results of the measurement of the ultrasonic resonance frequency showed that the frequency ratio varied with the magnitude of applied stress, the material of the specimen, and ultrasonic wave propagating direction with respect to the direction of the stress. They also showed that the ultrasonic wave resonance frequency measuring method is useful in finding the ultrasonic characteristics of materials under applied stress.

List of symbols

ρ	density
λ, μ	Lame's constants
l, m	Murnaghan's constants
σ	stress
Λ	wavelength
n	order number of resonance frequency
f_n	resonance frequency of n th order
ϵ	elastic strain
ν	Poisson's ratio
C	ultrasonic velocity
L	length of specimen

1. Introduction

The ultrasonic wave propagating characteristics under applied stress of various materials have been studied both theoretically and experimentally [1, 2]. In the past, the relationship between applied stress and ultrasonic wave propagation was usually measured by the pulse echo method. The measuring accuracy available in the pulse echo method is very good when measuring frequencies of 100 MHz or above. In measurements using specimens of single crystal, it is possible to detect and measure minute change of the ultrasonic resonance frequency down to the 4th decimal

[3]. However, the application of such a high-frequency ultrasonic wave for such measurements is impractical because of the attenuation of the ultrasonic wave when it penetrates normal steels and nonferrous metals. At present, the range of frequencies measurable in metals is from 5 to 10 MHz. Within such a range of frequency, it is difficult for the pulse echo method to check and examine accurately the relationship between applied stress and the ultrasonic characteristics.

This report gives the details of experiments carried out to investigate the ultrasonic characteristics of steels and aluminium alloys while applying stress to the sample. A continuous ultrasonic wave of approximately 5 MHz was used. Tensile load was applied to a test specimen with square cross-section, up to a point close to the yielding point, and the change of resonance frequency (about 5 MHz) was measured to a precision of 100 MHz. In this measurement, a change, which was considered to be ascribable to the material of the specimen, was measured in addition to the frequency fluctuation due to the geometrical aspects of the specimen.

The mode of resonance frequency change due to applied stress was seen to vary, depending

on whether the axis of tensile stress was perpendicular or parallel to the ultrasonic wave propagating direction. The change of ultrasonic wave propagating velocity has been reported by Hughes and Kelly [4]. A comparison was made between those results and the results obtained by the author.

2. Basic relationships

When the ultrasonic wave of wavelength Λ resonates to the n th order at the time of propagating through a test specimen of length L ,

$$n \cdot \Lambda/2 = L \quad (1)$$

If an assumption is made that the velocity of the ultrasonic wave is C , the resonance frequency is $f_n = C/\Lambda$, and so

$$f_n = nC/2L \quad (2)$$

When no stress is applied to the test specimens, we obtain the expression

$$f_{n_0} = nC_0/2L_0. \quad (3)$$

where the subscript zero indicates zero stress.

For the resonance frequency, a value was measured which was thought to vary with the geometrical proportions of the test specimens as they changed with stress, as well as with the properties of the materials used for individual test specimens. Therefore, when applying the Hughes and Kelly formula [4] for the ultrasonic wave propagating velocity and stress, with the direction of the applied stress parallel to the ultrasonic wave propagating direction the following equation is obtained (referred to later as a parallel method);

$$\begin{aligned} \rho C^2 &= \lambda + 2\mu + \frac{\sigma}{3\lambda + 2\mu} \\ &\left\{ 2l + \lambda + \frac{\lambda + \mu}{\mu} (4m + 4\lambda + 10\mu) \right\} \\ &= \alpha + \beta\sigma \end{aligned} \quad (4)$$

where $\alpha = \lambda + 2\mu$

$$\beta = \frac{1}{3\lambda + 2\mu} \left\{ 2l + \lambda + \frac{\lambda + \mu}{\mu} (4m + 4\lambda + 10\mu) \right\} \quad (5)$$

If the test specimen undergoes geometrical change as much as ϵ per unit length in the tensile axis due to elastic deformation, the length of specimen L where the measurement of resonance

frequency is performed is

$$L = L_0(1 + \epsilon). \quad (6)$$

Hence, the density involved is obtained from the expression

$$\rho = \rho_0/(1 + \epsilon)(1 - \nu\epsilon)^2 \quad (7)$$

where ν is Poisson's ratio.

When obtaining the ratio f_n to f_{n_0} by applying Equations 4, 6 and 7;

$$\frac{f_n}{f_{n_0}} = \frac{CL_0}{C_0L} \simeq 1 - \left(\frac{1}{2} + \nu\right)\epsilon + \frac{\beta}{2\alpha}\sigma \quad (8)$$

The first and second terms of the above equation represent the rate of frequency change corresponding to the geometrical change of test specimens, while the third term is related to the apparent change of the elastic modulus due to applied stress.

The following equation is obtained when the direction of applied stress is perpendicular to the ultrasonic wave propagating direction (referred to later as a perpendicular method),

$$\begin{aligned} \rho C^2 &= \lambda + 2\mu + \frac{\sigma}{3\lambda + 2\mu} \left\{ 2l - \frac{2\lambda}{\mu} (m + \lambda + 2\mu) \right\} \\ &= \alpha + \beta', \end{aligned} \quad (10)$$

where $\alpha = \lambda + 2\mu$

$$\beta' = \frac{1}{3\lambda + 2\mu} \left\{ 2l - \frac{2\lambda}{\mu} (m + \lambda + 2\mu) \right\}.$$

Symbols β and β' are variables containing the Murnaghan's constant inherent in the materials used for the individual test specimens [4]. In the measurement of resonance frequency by the perpendicular method, the length of the measured part of the specimen decreases by $\nu\epsilon$ per unit length; therefore,

$$L = L_0(1 - \nu\epsilon) \quad (11)$$

The density involved varies in accordance with Equation 7. As in Equation 8, when obtaining the value of f_n/f_{n_0} by using Equations 7, 9 and 11,

$$f_n/f_{n_0} \simeq 1 + \frac{1}{2}\epsilon - \beta'/2\alpha\sigma \quad (12)$$

The individual terms in Equation 12 are the same as in Equation 8.

In this way, it is possible to obtain the change of resonance frequency ratio due to applied stress, when the ultrasonic wave is propagated through the test specimen in directions parallel and perpendicular to the tensile axis.

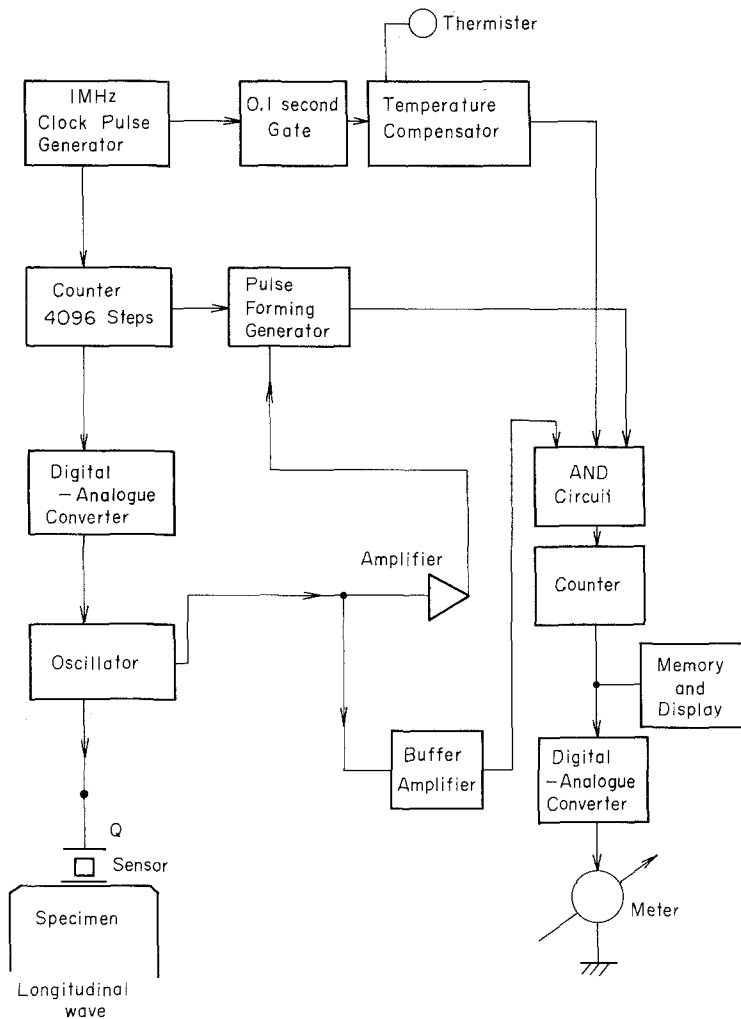

Figure 1 Block diagram of the measurement system.

3. Apparatus and specimens

3.1. Resonance frequency measuring instruments

The frequency was fixed at approximately 5 MHz and modulated to an amplitude of about 0.4 MHz. The resonance frequency measuring instrument was designed to display automatically the measured resonance frequency on the counter three times per second when the ultrasonic wave was at resonance in the test specimens.

The frequency modulation for one step of the counter was set to 100 Hz. In this case, the frequency was varied in a total of 4096 steps, and when the ultrasonic wave was made to resonate, the amplitude of the receiving voltage was at its minimum. The frequency modulation was stopped using a differential network when the

minimum amplitude was detected. Thereafter, the resonance frequency was displayed by reading out the frequency at the gate with a time accuracy of 0.10 000 sec. With this instrument, if the resonance frequency changes due to the surface temperature fluctuations of the specimen over the range 0° to 70° C were known, the influence of the surface temperature of the specimen can be automatically compensated for.

In our experiment, we kept the temperature of the instrument and the specimen as $25 \pm 2^\circ \text{C}$ and did not need to use the automatic compensating capability of this equipment. Fig. 1 shows a block diagram of the resonance frequency measuring instrument, and Fig. 2 is a photograph of the instrument.

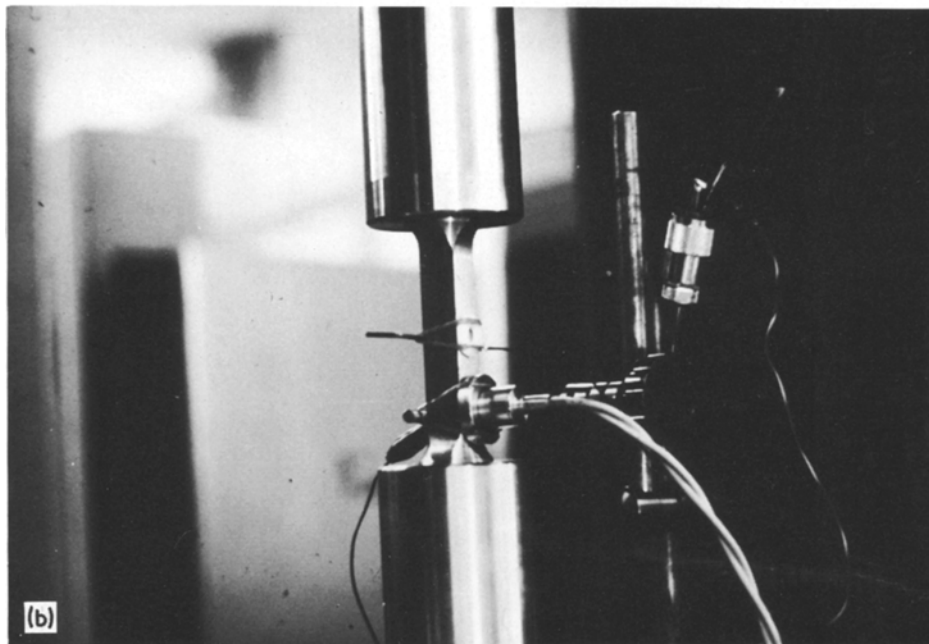

Figure 2 (a) The measuring instrument; (b) the specimen under test.

3.2. Sensors and their coupling medium

A quartz vibrator featuring an X-cut and which had an outside diameter of 8 mm, with a resonance frequency of 5 MHz, was used as a sensor. A lead-zirconate-titanate (PZT) sensor can also be used, and it has a greater sensitivity than that available from the quartz vibrator. Glycerin was employed as coupling medium.

3.3. Tensile testing machine

A tensile testing machine, the TOM-10 000X, designed for a maximum load of 10 tons and made by Shinko Tsushin Co., Ltd., was used to apply the tensile load to the test specimens.

3.4. Specimens

The steels and aluminum alloys shown in Table 1

TABLE I Specimens

Specimen	Chemical composition (%)					Hardness H.B.	Final treatment
	C	Cu	Si	Mg	Mn		
Steel							
JIS SM41 (SAE 1021)	0.16		0.25		0.68	114	As-rolled
JIS S20C (AISI 1020)	0.23		0.28		0.48	135	As-rolled
JIS S30C (AISI 1030)	0.27		0.25		0.66	157	As-rolled
*JIS S35C (AISI 1035)	0.32-0.38		0.15-0.35		0.60-0.90	-	As-rolled
JIS S40C (AISI 1040)	0.41		0.27		0.77	217	As-rolled
JIS S45C (AISI 1045)	0.43		0.24		0.73	245	As-rolled
JIS S50C (AISI 1050)	0.47		0.25		0.77	229	As-rolled
Aluminium alloy							
*JIS A5083 (ASTM 5083)		0.10	0.40	4.0-4.9		-	As-rolled and annealed
JIS A5056 (ASTM 5056)		Trace	0.08	4.70		86	As-extruded
JIS A5056 (ASTM 5056)		Trace	0.08	4.70		54	As-extruded and annealed

JIS: Japanese Industrial Standards; (): US Standard.

*From JIS handbook.

were machined to the shape shown in Fig. 3, and used as test specimens. The gauge length at the parallel part of the test specimens was 60 mm while the cross-section was a square with side 12 mm. Fig. 3 shows the position of sensor set on the test specimens.

4. Experimental results

4.1. Parallel method

As shown in Fig. 3, a sensor to measure the resonance frequency was attached to one end of the test specimen after the specimen was mounted on the tensile testing machine. The resonance frequency was stabilized at zero load conditions and then the tensile load was applied to the test

specimen at a cross-head speed of 0.03 mm min⁻¹, with a strain rate of 8.3 × 10⁻⁶ sec⁻¹.

The resonance frequency was read out at 100 kg intervals of applied load increase, using the X-Y recorder, and measurements were taken up to a point close to the yielding point of the test specimen. When the test specimen yielded and plastic flow occurred, the resonance frequency varied greatly, making measurement difficult. Fig. 4 shows the relationship $\sigma - f/f_0$ between

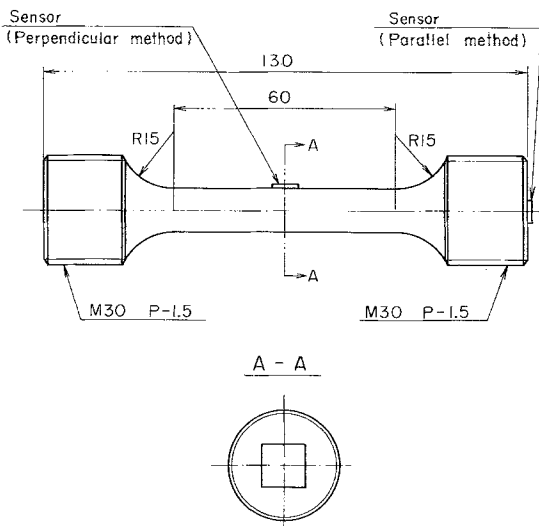

Figure 3 Diagram of the specimen showing positioning of the sensor for both parallel and perpendicular methods.

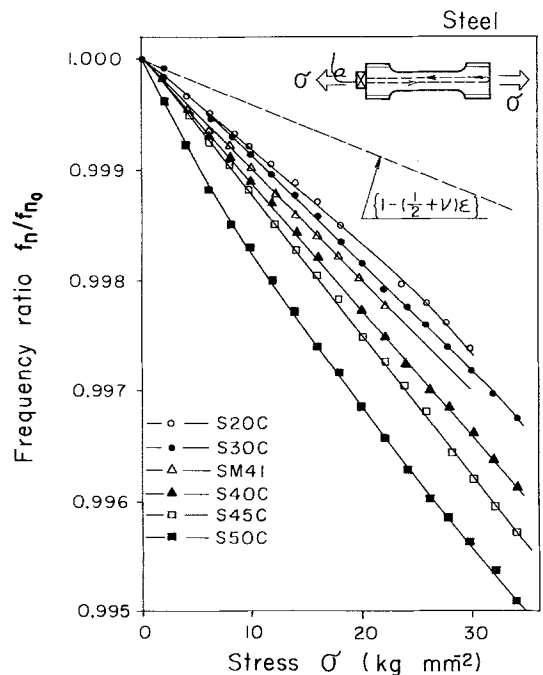

Figure 4 Frequency ratio versus tensile stresses of steels (parallel direction).

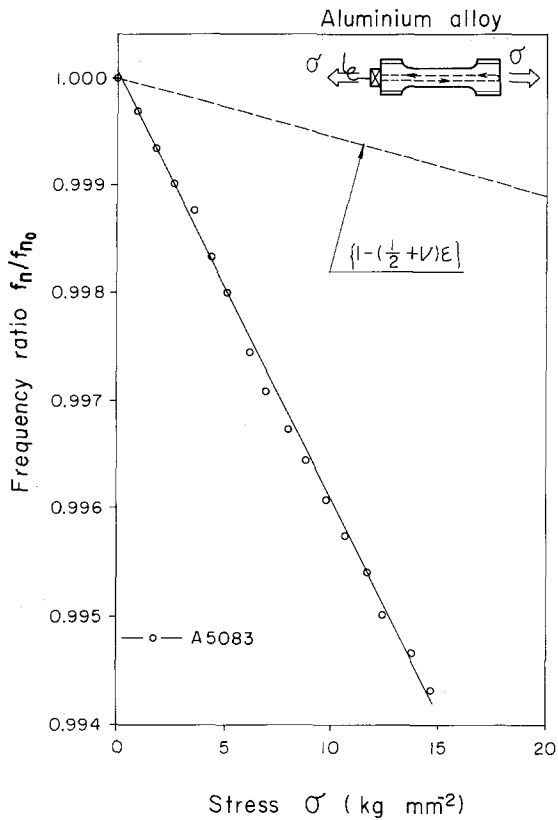

Figure 5 Frequency ratio versus tensile stresses of aluminium alloys.

stress and frequency ratio determined by measuring the resonance frequency using the parallel method under applied tensile load to the test specimen of steel. This figure shows how the frequency ratio changes with increasing carbon content.

Fig. 5 presents the results of similar measurements of resonance frequencies for a test specimen of aluminium alloy. The broken lines of Figs. 4 and 5 show the calculated value of $1 - (\frac{1}{2} + \nu)\epsilon$ which is obtained by excluding the 3rd term from Equation 8, and the contribution of elastic strain of the specimens to the frequency ratio. Reference was made to the American Institute of Physics Handbook for Young's modulus [5].

4.2. Perpendicular method

The sensor was attached to the centre portion of the parallel part of tensile specimen and the resonance frequency was measured at right angles to the tensile axis. Figs. 6 and 7 show the results of the measurements, plotting the relation between stress and frequency ratio. As referred to above, the broken lines represent a calculated value

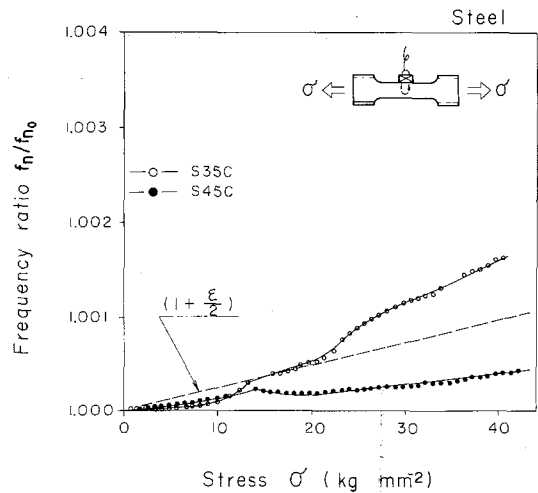

Figure 6 Frequency ratio versus tensile stresses of steels.

of $1 + \frac{1}{2}\epsilon$, the change of frequency ratio caused by the geometrical distortion in the test specimens.

The change of observed frequency ratio due to the applied stress is not as simple as was seen in Figs. 4 and 5 but the curve fluctuates with a certain amplitude. Particularly with extruded aluminium alloy A5056, a relatively conspicuous break was observed before the yielding point. On the other hand, with annealed aluminium alloy the resonance frequency was observed to fluctuate slightly on the side of lower stress.

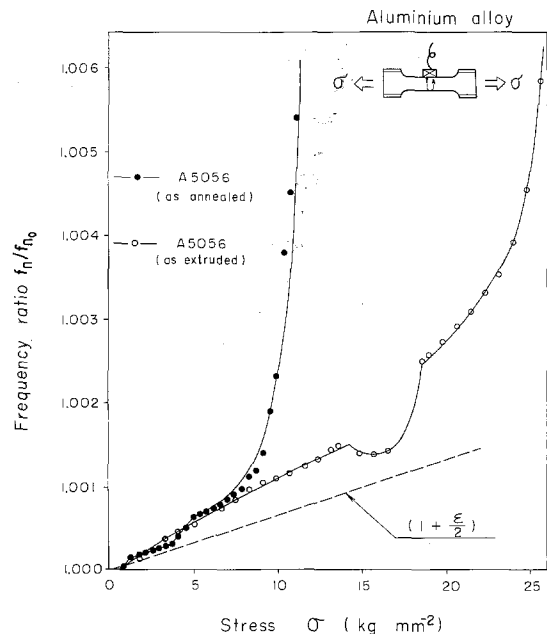

Figure 7 Frequency ratio versus tensile stresses of aluminium alloys.

Also with S35C and S45C steels, dimpled curves were observed, but the fluctuation of resonance frequency was not so large.

5. Discussion

A longitudinal ultrasonic wave of approximately 5 MHz was applied to the specimen using the parallel method, the length L of the measuring section of the test specimen was 130 mm, and the order number, n of the resonance frequency was 220. Compared with the standard resonance frequency, the change in ultrasonic characteristics due to applied stress was 220 times, from the relation, $f_n = nC/2L$.

If the pulse echo method is used, the change of ultrasonic characteristics due to applied stress corresponds to the 220 th bottom echo. Accordingly, it is possible to discover such changes of ultrasonic characteristics by measuring the time T of the n th echo referring to the relation $T = 2Ln/C$. However, in actual conditions the number of available echoes is only ten or fewer due to the attenuation.

The ultrasonic wave resonance method is more precise than the pulse echo method. Regrettably, however, if length L of the test specimen is larger than 150 mm, the interval of resonance frequency decreases, making it difficult to proceed with measurement. In such a case, the sing-around method and the phase difference detecting method are supposed to be effective for the measurement involved [5].

As is clear from Figs. 4 and 5, the measuring accuracy available in the ultrasonic wave frequency resonance method seems to be excellent. Reviewing the curve (Fig. 4) of the relation between applied stress and frequency ratio, by the parallel method, it is clear that the frequency ratio changes systematically with carbon content, thus verifying that the frequency resonance method is superior in regard to experiment reproducibility. Fig. 8 shows that the curve of measured stress and frequency ratio up to a certain stress level matched well the locus drawn at the time of applying and relieving stress to and from the test specimens.

The resonance frequency varies with the external force applied to the test specimens, but the frequency change was shown not to be equivalent to the amount of deviation from the value calculated on the assumption that the test specimens would be subjected to elastic distortion.

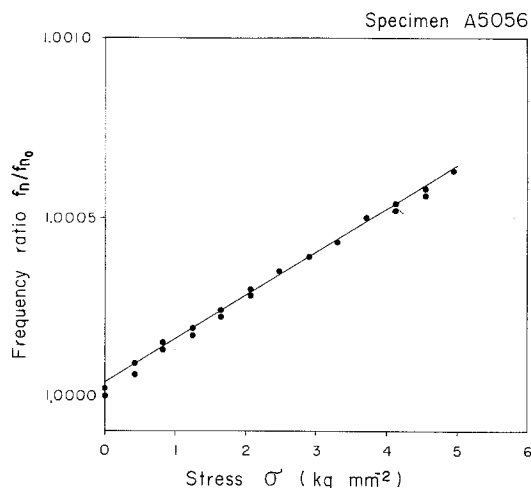

Figure 8 Hysteresis curve for the frequency ratio versus tensile stresses (perpendicular direction). The points are obtained by taking twice the measurements for increasing and decreasing stresses.

The size of this deviation was proved to have increased with carbon content in measurements by the parallel method, thus showing that the stress–frequency ratio depends on material. In the case of test specimens of aluminium alloy, the rate of deviation was larger in comparison to steel, as is clear from Fig. 5.

The results of measurement by the perpendicular method should be noted when using aluminium alloy test specimens. Referring to Fig. 7, the curve is broken at a part corresponding to the point below the range of stress equivalent to the yield stress. Especially with extruded materials, the curve is broken more conspicuously. For annealed materials, the curve deviates markedly from the broken line, drawn on the assumption that the test specimens would be subjected to a geometrical change due to elasticity, at a point around a stress of 10 kg mm⁻², and within the region of less than 5 kg mm⁻², the curve is also dimpled irregularly. With S35C and S45C steels, the curve from the perpendicular method is also dimpled irregularly at a point lower than the yield stress. The results from the parallel method on aluminium alloy test specimens show only a slight dimple.

Measurements were carried out under applied tensile stress at a strain rate of 8.3×10^{-6} sec⁻¹. In this case it is considered that the partial plastic flow occurs below the yield stress and it affects the resonance frequency. Nakanishi and Sato reported that the yielding of the surface layers of

the test specimens was caused prior to bulk yielding [6]. The test specimen contains a stationary wave, the maximum magnitude of both its ends being on the surfaces of the specimens.

As is evident from Fig. 3, the maximum magnitude of both edges of the stationary wave are directly influenced by distortion of the specimen in the perpendicular method, but they are not directly influenced in the parallel method. Therefore, it is believed that the change occurring in the surface layer can be detected more sensitively by the perpendicular as compared with the parallel method. Hence, the reflection of the curve as given in Figs. 6 and 7 would have been observed by applying the perpendicular method.

The measured resonance frequency ratios were larger or smaller than the calculated ones due to geometrical changes in the specimens, but they were larger than calculated only in the parallel method. The apparent elastic modulus has a tendency to decrease as tensile stress increases for both specimens of steel and aluminium alloy, as shown in Figs. 4 and 5. However using the perpendicular method, the apparent elastic modulus has a tendency to increase for aluminium alloy, while there are both tendencies to increase and decrease for steel. If the values of α , β and β' in the Equations 8 and 12 are obtained, it should be possible to discuss such behaviour in more detail, and it is the subject of a future study.

Summary and conclusions

(1) The change of resonance frequency due to the stress applied to the specimens of steel and aluminium alloy was measured by propagating an ultrasonic wave of about 5 MHz through these specimens in directions parallel and perpendicular to the tensile axis, under tensile stresses up to near the yielding point.

(2) The relation between resonance frequency ratio and stress obtained by measurement in the direction parallel to the tensile axis is a monotonous line, which has values higher than the

calculated line because of geometrical changes due to applied stress.

(3) The relation between resonance frequency ratio and applied stress measured in the direction perpendicular to the tensile axis is a curve which has an inflection. The larger inflection was observed in the curve of extruded aluminium alloy, as compared with steel.

(4) The apparent elastic modulus has a tendency to decrease as tensile stress increases for both specimens of steel and aluminium alloy. However, in the perpendicular method it has a tendency to increase for aluminium alloys, while there are both tendencies to increase and decrease for steel.

(5) The ultrasonic wave resonance frequency measuring method was verified by this experiment to give higher precision than the pulse echo method in the measurement of ultrasonic characteristics.

Acknowledgements

The author hereby express his heartfelt thanks to Dr Hidehiko Yoshida and Dr Eiichi Ozawa of the National Research Institute for Metals, and Mr Jun Tsuji of Tokyo Keiki Co., Ltd. for their help in the preparation of this paper.

References

1. H. J. McFALL, *Materials Evaluation* 32 (1974) 244.
2. V. M. BOVRENKO and I. I. AVERBUKH, *Defektoskopiya* (USSR) 1 (1974) 72.
3. A. HIKATA, *Bull. Japan. Nat. Res. Inst. Mech. Eng.* 39 (1961) 64.
4. D. S. HUGHES, J. L. KELLY, *Phys. Rev.* 5 (1953) 1145.
5. D. E. GRAY, "American Institute of Physics Handbook" (McGraw-Hill, New York, 1957) p. 61.
6. H. J. McSKIMIN, *J. Acoust. Soc. Amer.* 5 (1961) 606.
7. F. NAKANISHI and K. SATO, "Zairyo Rikigaku" (Iwanami Shote Co. Ltd., 1975) p. 69.

Received 22 June and accepted 25 July 1977.